

INNOVA Mini K

Divert Single Seat Valve



APPLICATIONS

The INNOVA Mini K valve is a pneumatic single seat valve. It uses to divert the product with a converging flow in hygienical applications of the food, beverages, pharmaceutical or chemical industries.

DESIGN AND FEATURES

Hygienic design according to EHEDG.

Gasket with specific profile guarantees reliability under adverse working conditions.

Hygienic design of the gasket ensures optimal cleaning.

Single-acting pneumatic actuator.

Normally closed valve (NC) in its standard version.

The valve can be changes to normally open (NO) by simply reversing the position of the pneumatic actuator.

Easy disassembly of internal parts by loosening a clamp fastener.

Open lantern allows visual inspection of shaft sealing.

TECHNICAL SPECIFICATIONS

Materials

Parts in contact with the product	1.4404 (AISI 316L)
Other steel parts	1.4301 (AISI 304)
Seals in contact with the product	EPDM

Surface finish

Internal	Brigh polish $Ra \leq 0,8 \mu m$
External	Matt

Sizes available

DIN EN 10357 serie A (formerly DIN 11850 series 2)	DN 10 - DN 15 - DN 20
ASTM A269/270 (correspond to OD pipe)	OD $\frac{1}{2}$ " - OD $\frac{3}{4}$ "

Connections

Weld

Operating limits

Working temperature	-10°C to 121°C
SIP temperature	140°C (maximum 30 minutes)
Maximum working pressure	1000 kPa (10 bar)
Minimum working pressure	Vacuum
Compressed air pressure	6 - 8 bar

OPTIONS

Double-acting pneumatic actuator.
 Seals: FPM and HNBR.
 Other connections: male and clamp.
 External position sensors.
 Surface finish $Ra \leq 0,5 \mu m$.

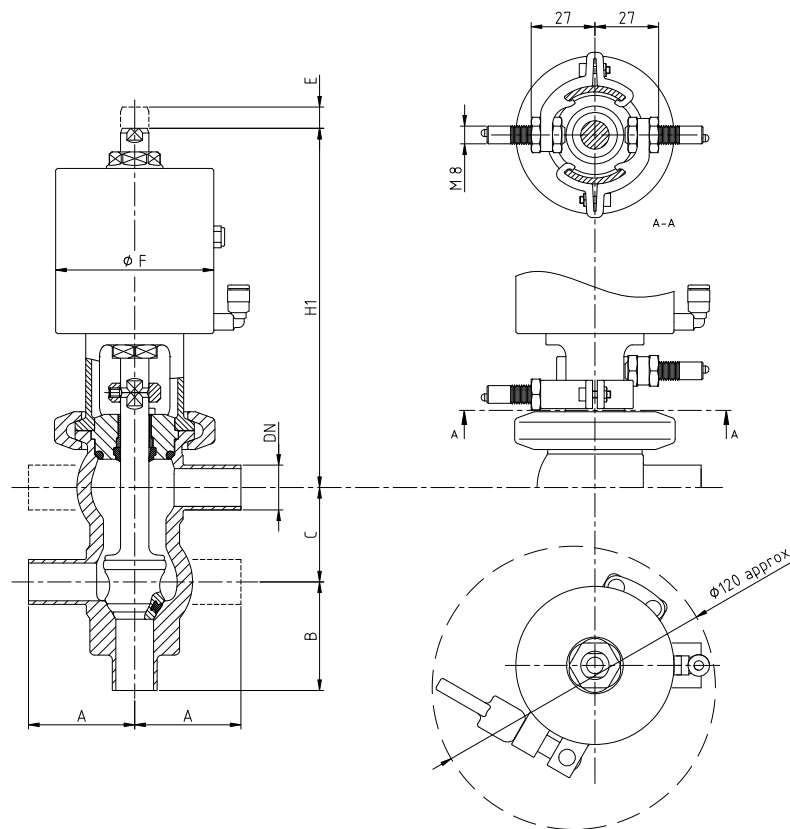
DIMENSIONS

10.260.32.0040

	DN	Pipe	A	B	C	ØF	E	H1	kg ¹
DIN	10	13,0 x 1,50	45	43	40	67	9	155	2,3
	15	19,0 x 1,50	45	46	40	67	9	152	2,4
	20	23,0 x 1,50	45	48	40	67	9	150	2,4
OD	½"	12,7 x 1,65	45	43	40	67	9	155	2,3
	¾"	19,05 x 1,65	45	46	40	67	9	152	2,4

1) The weights correspond to the HC housing combination

HOUSING COMBINATIONS



HA-0



HB-90



EB-90

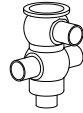

FB-90

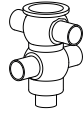

GB-90



HC-180

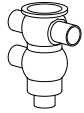

EC-180

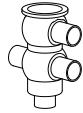

FC-180

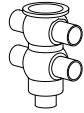

GC-180



HD-270

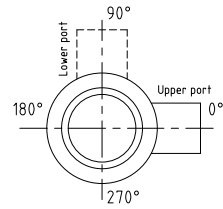

10.260.32.0053

MAXIMUM PRESSURES

Maximum pressure in bar / PSI without leakage at the valve seat

Actuator / valve body combination and direction of pressure	Air pressure [bar] / [PSI]	Plug position	DN 10	DN 15	DN 20
			OD 1/2"	OD 3/4"	
	-	NC	10 / 145	10 / 145	10 / 145
	6 / 87	NC	10 / 145	10 / 145	10 / 145
	-	NO	10 / 145	10 / 145	10 / 145
	6 / 87	NO	10 / 145	10 / 145	10 / 145
	6 / 87	A/A	10 / 145	10 / 145	10 / 145
	6 / 87	A/A	10 / 145	10 / 145	10 / 145

Maximum pressure in bar / PSI against which the valve can open

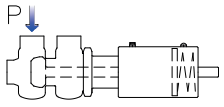
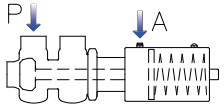
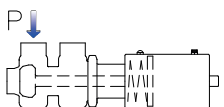
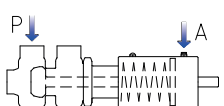
Combinación de actuador / cuerpo válvula y dirección de presión	Presión de aire [bar] / [PSI]	Posición obturador	DN 10	DN 15	DN 20
			OD ½"	OD ¾"	
	-	NC	10 / 145	10 / 145	10 / 145
	6 / 87	NC	10 / 145	10 / 145	10 / 145
	-	NO	10 / 145	10 / 145	10 / 145
	6 / 87	NO	10 / 145	10 / 145	10 / 145

A ≡ air

P ≡ product pressure

NC ≡ normally closed valve

NO ≡ normally open valve

A/A ≡ double acting valve

Valid values for standard actuators

For other pressures, bigger actuators can be assembled